

# THEREC CORPORATION LTD.

## Bulk Material Handling Equipment



Drop Through Rotary valve / normal , quick detachable and dairy valve type



Blow Through Rotary valve / normal , quick detachable and dairy valve type



Diverter valve / Flap type , Plug type , Hammer type and Fill Vent valve



Explosion Vent Panel

Bursting sensor



Flame Arrestor



**Therec Corporation Ltd.**

Tel (662) 416 8467-8, (662) 0899 4097

88 Soi Karnjanapisek 4/2 Karnjanapisek Rd. Bangbon Bangkok  
10150 Thailand

[www.therecorp.com](http://www.therecorp.com)

Fax : (662) 416 8469

General product TRC 07 / 2015

# Bulk material Handling Equipment



Flexible Spiral Conveyor

Capacity : 120-10,000 kg/hr / Tube size 40-130 mm. / Bulk Density up to 700 kg/m<sup>3</sup>

Tipo Model	Portata in Kg/h. Capacity load in Kg/h.		R (mm)	Gruppo Group
	$\alpha = 0^\circ$	$\alpha = 45^\circ$		
mod. $\phi e$				
MA 40	180	120	800	G 1
MA 55	500	340	1000	G 1
MA 65	1100	720	1300	G 1
MA 70	1600	1080	1500	G 1
MA 80	2300	1540	2100	G 2
MA 90	3200	2100	2500	G 2
MA 100	4500	3000	2800	G 3
MA 110	6000	4000	3200	G 3
MA 120	7500	5200	4000	G 4
MA 130	10000	7000	5000	G 4

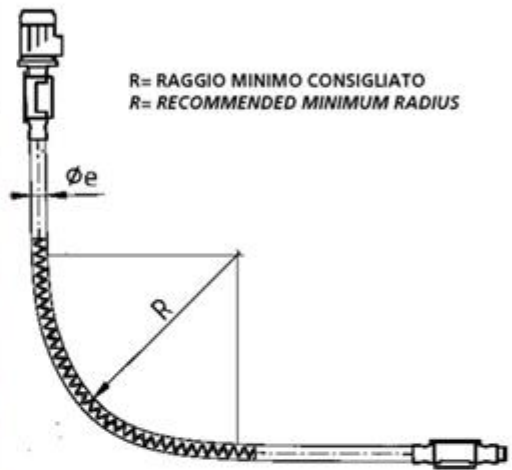

Very Flexible Conveyor for various Requirement in many system ,many machines and many processes

$\alpha$  = Inclinazione al prelevamento  
Velocità angolare della spirale: 930 r.p.m.  
Densità apparente considerata: 0,7 kg/dm<sup>3</sup>

$\alpha$  = Picking inclination  
Spiral angular speed: 930 r.p.m.  
Considered bulk density: 0,7 kg/dm<sup>3</sup>

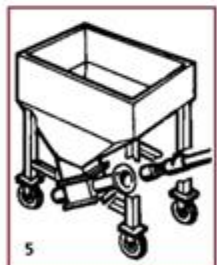

5  
Innesito IRS  
IRS Coupling



6  
Sonda SLL  
SLL Probe



7  
Da silo  
From Silo



8  
Carico Silo  
Silo loading



9  
Estrattore da mulino  
Mill extractor



10  
Da Vibrovaglio  
From vibrating screen



11  
Attacco per aspiratore pneumatico  
Connection for vacuum conveyor



12  
Da Big Bag  
From Bulk Bag

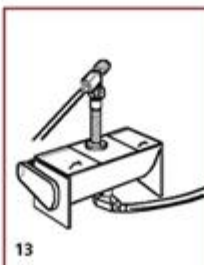

13  
Da Miscelatore orizzontale  
From Horizontal Mixer

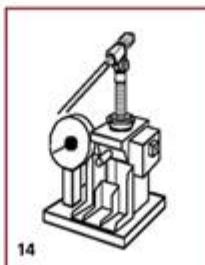

14  
Alimentazione Bilancia Insaccatrice  
Bag filling machine scale feeding



15  
Alimentazione dosatore  
Batcher feeding



16  
Rompiponte / Estrattore  
Bridge Breaker / Extractor

# Bulk material Handling Accesories



**In-line static equipment**  
IG = CL - 10mm  
(Minimum)



**Off Set equipment**  
IG = CL - 20mm  
(Minimum)



**Oscillating equipment**  
IG = CL - 40mm  
(Minimum)



Seeflex Regulations - EC, FDA, USDA, 3A

## FROM THIS....



## TO THIS....

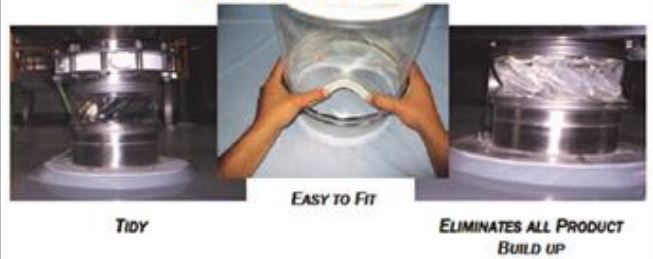

Industrial Flexible hose for air, gas and bulk material transferring



*Our Quality Commitment*



Pneumatic conveying pipe compression coupling and sight glass

[www.thereccorp.com](http://www.thereccorp.com)



## Bulk Material Handling Machine

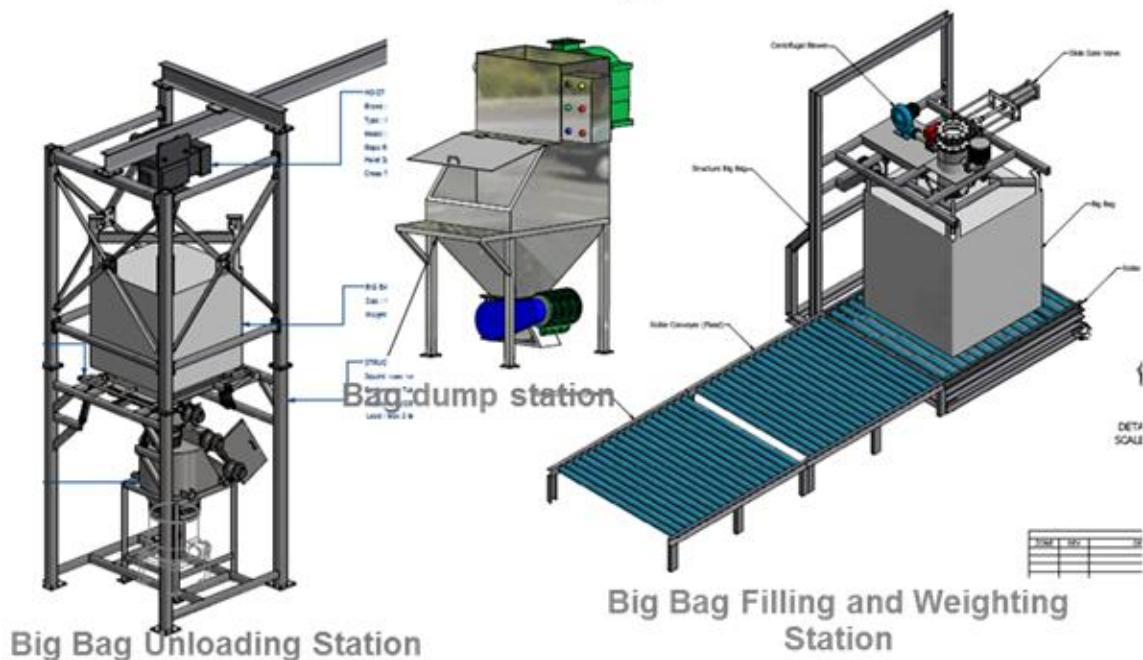

Big Bag Unloading Station

Big Bag Filling and Weighting Station

Food grade Screw Conveyor

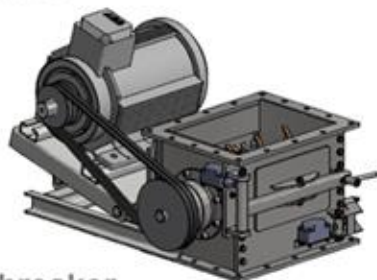

Lump breaker



Aero Mechanical Conveyor



Centrifugal Sifter



MF300

Compact and economical inline measurement



Flow\_switch



Mass flow meter

Therec Processing Machine Co., Ltd. [www.trpm.co.th.com](http://www.trpm.co.th.com)

Tel ( 662) 893 9003-4 (5 lines)

Fax : (662) 893 9005 ,893 9178

88 Soi Karnjanapisek 4/2 Karnjanapisek Rd. Bangbon Bangkok  
10150 Thailand

General product TRPM 01 / 2014